

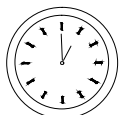

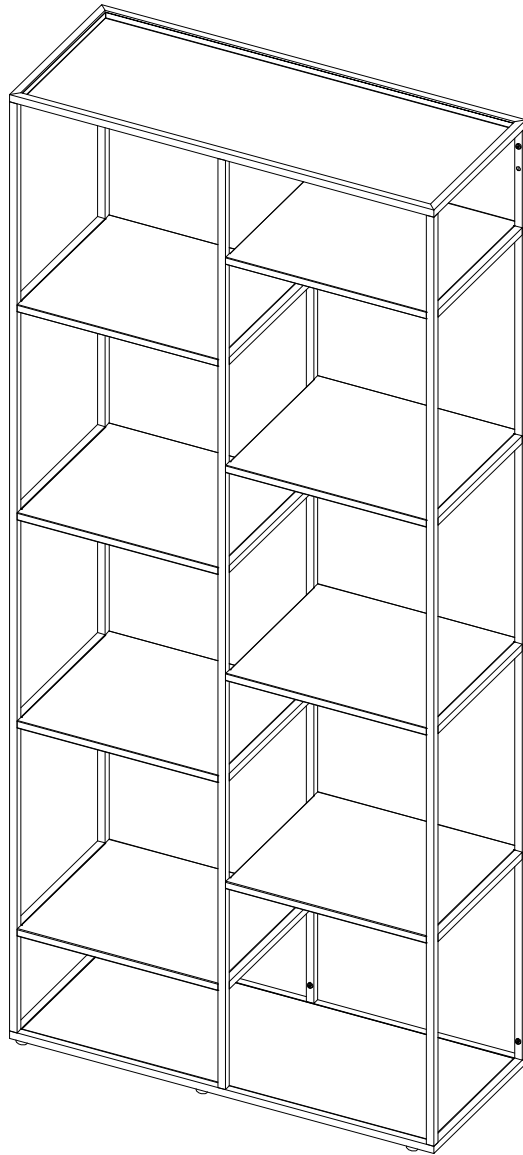

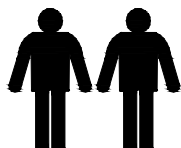

JUNE

cabinet 85cm

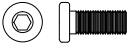

30MIN



A	X44	B	X1	C	X6	D	X2	E	X2
 M6*12mm						 M4*40mm		 Ø8mm	
F	X2								
 Ø5mm									

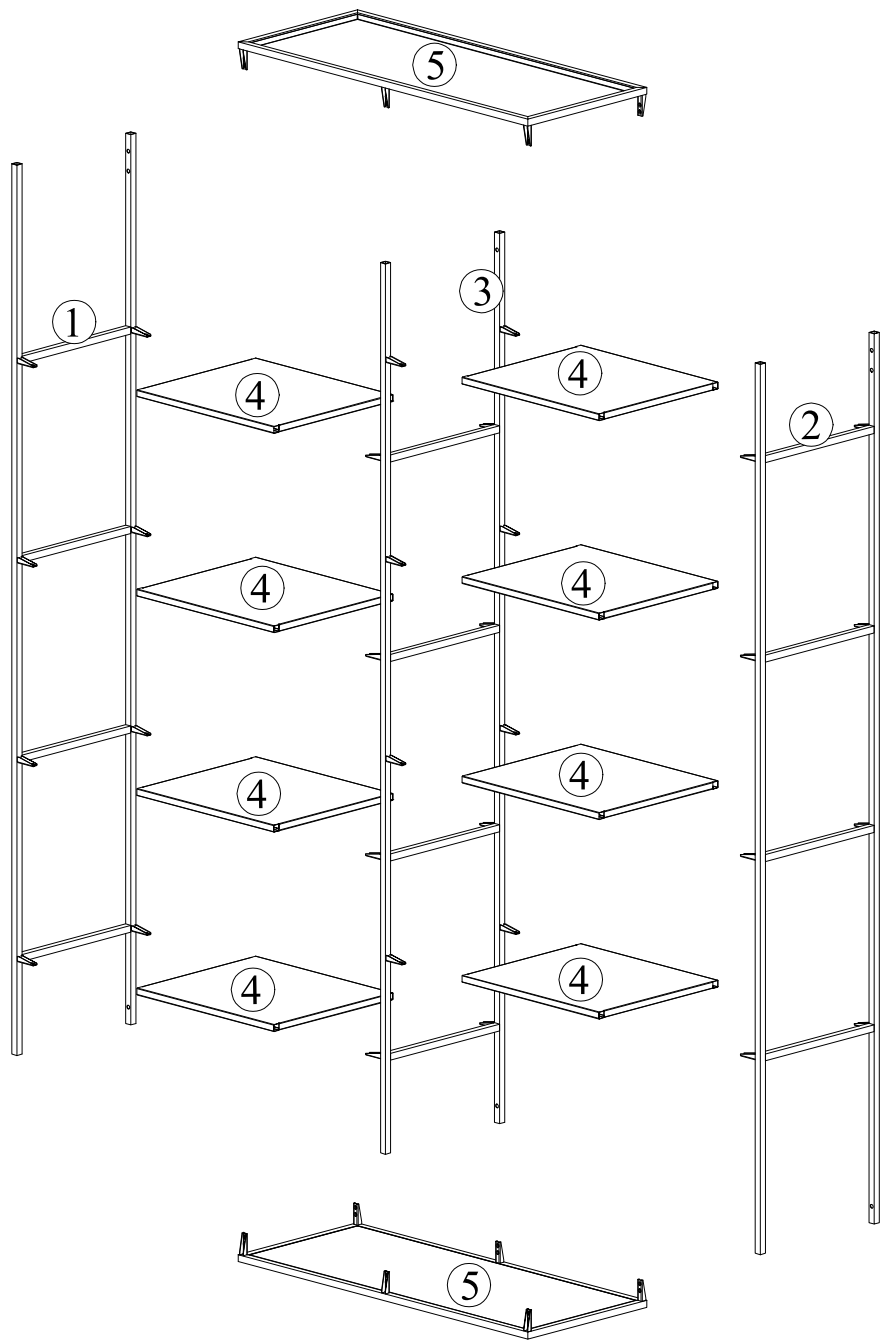

1

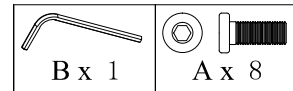
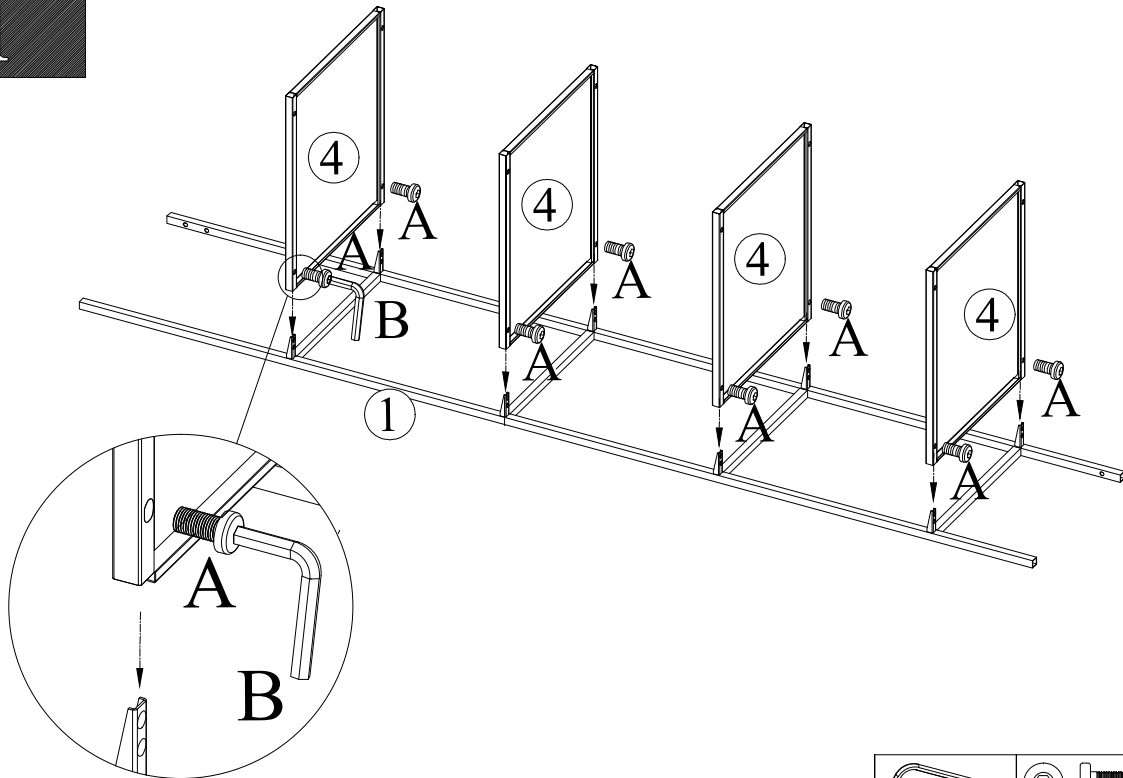

2

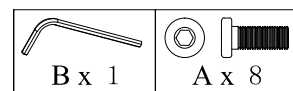
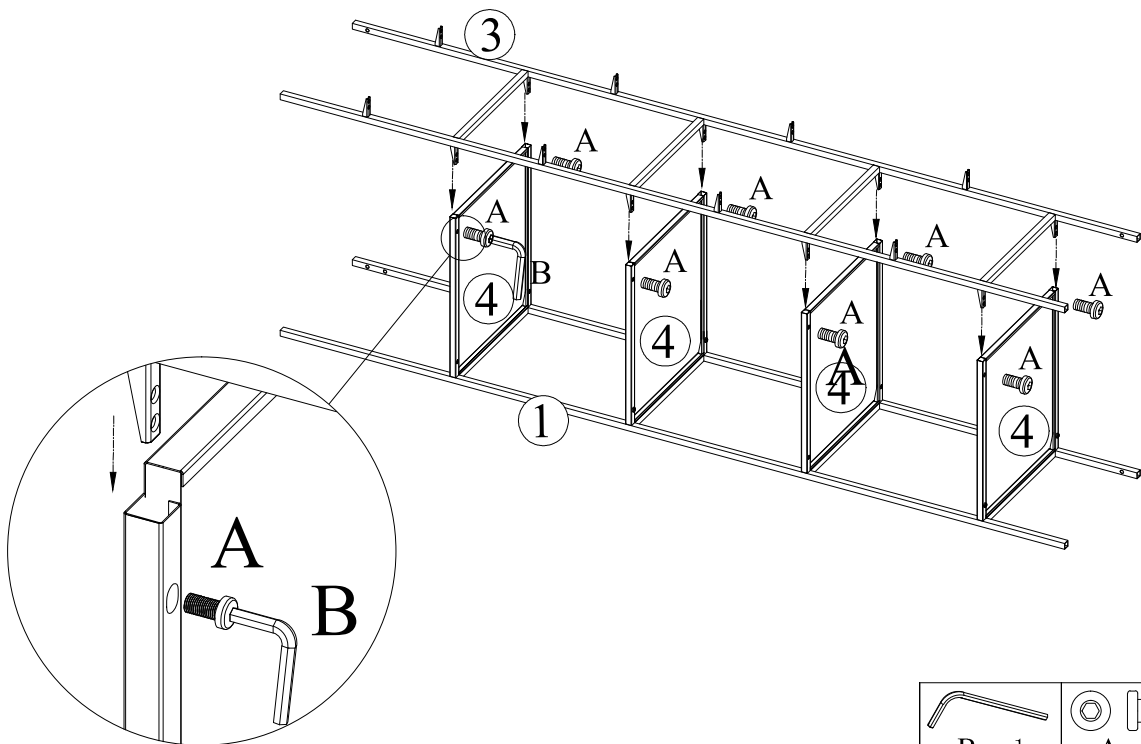

3

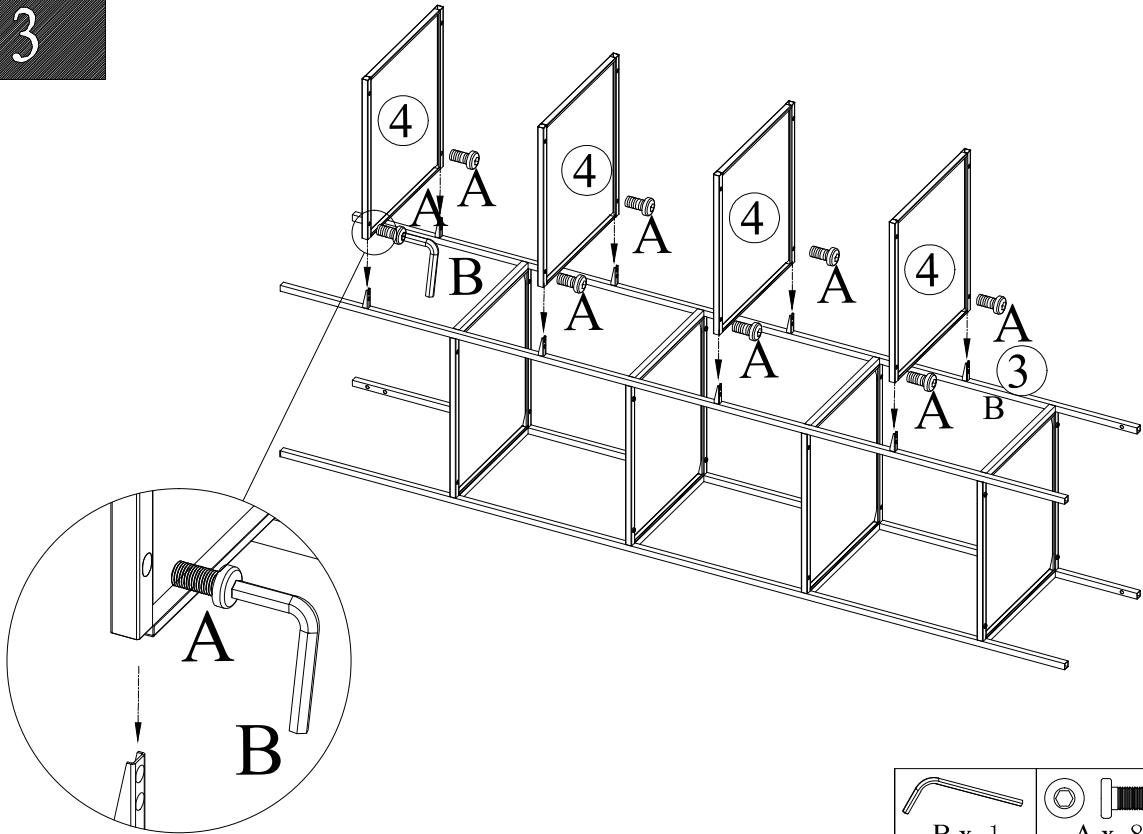

4

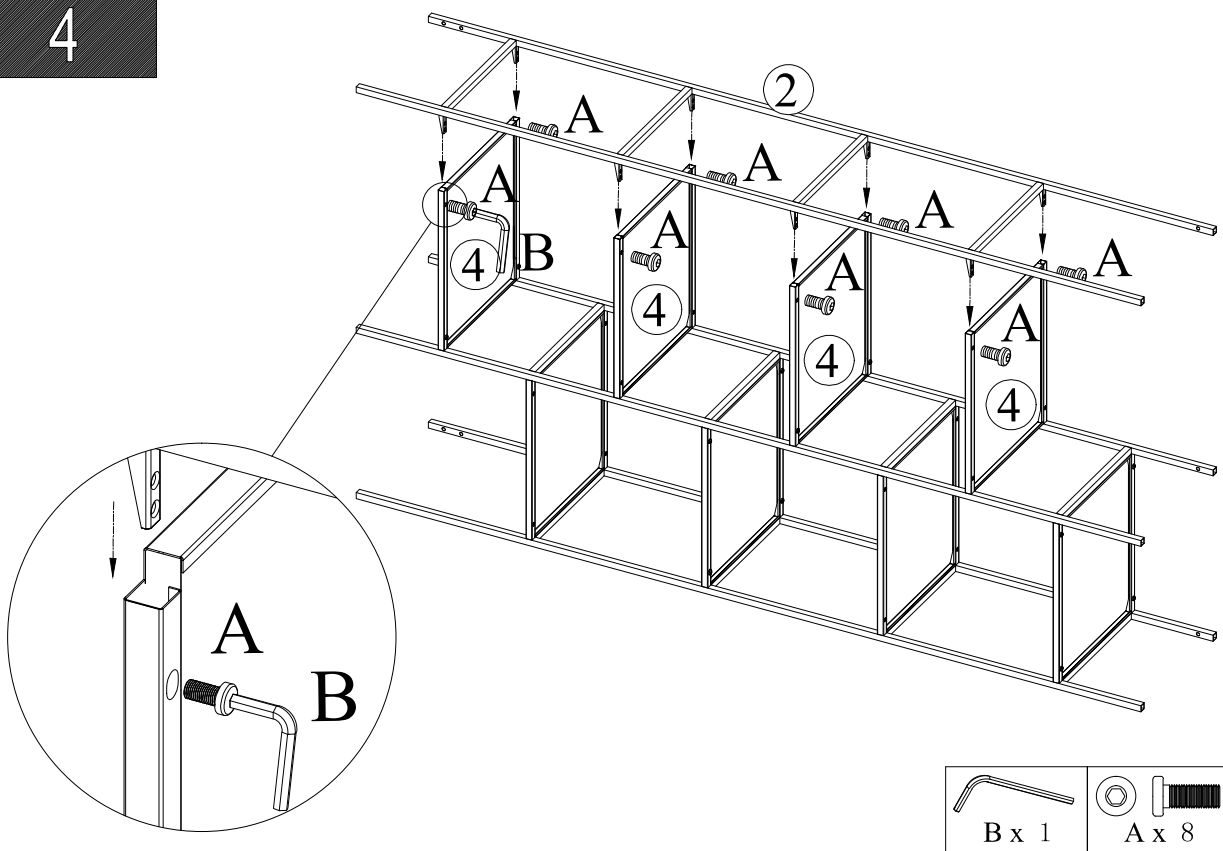

5

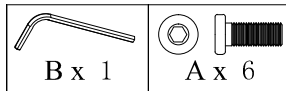
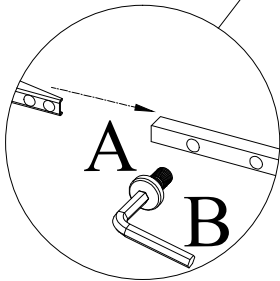
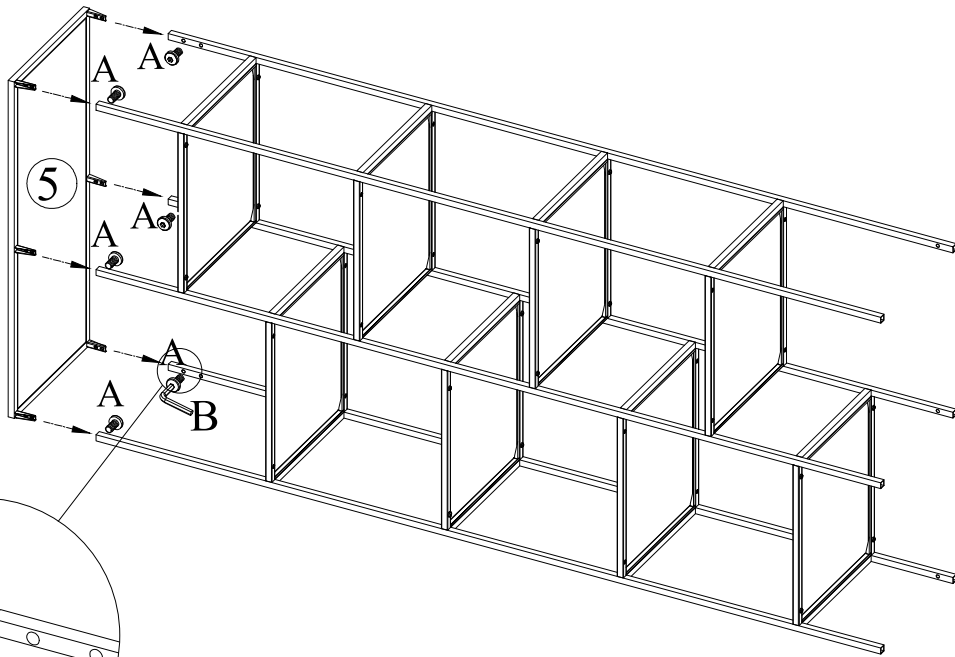

6

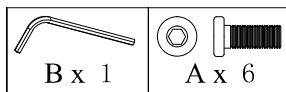
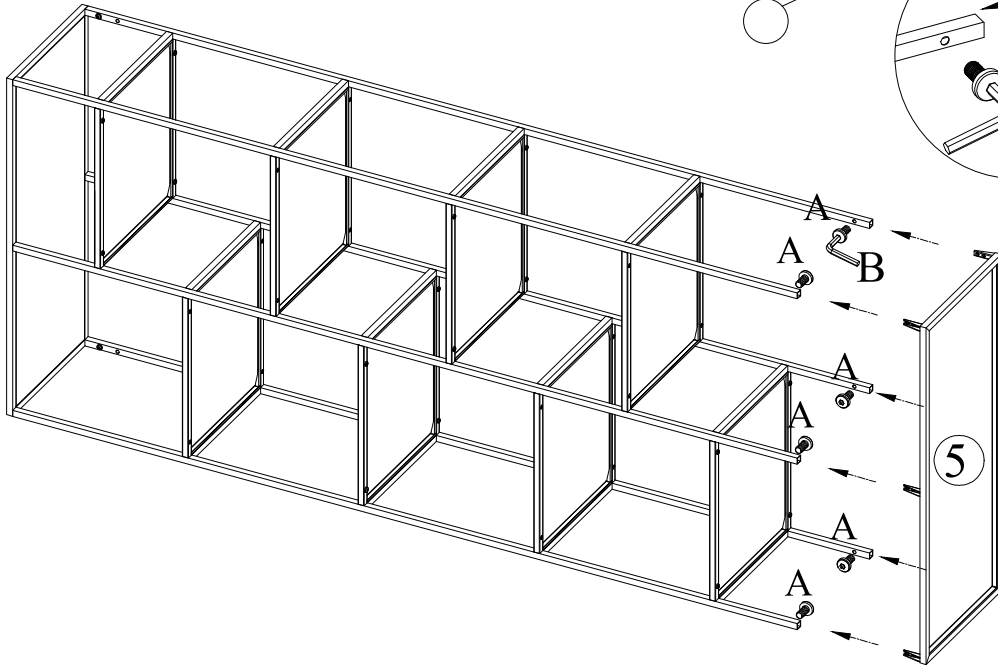

7

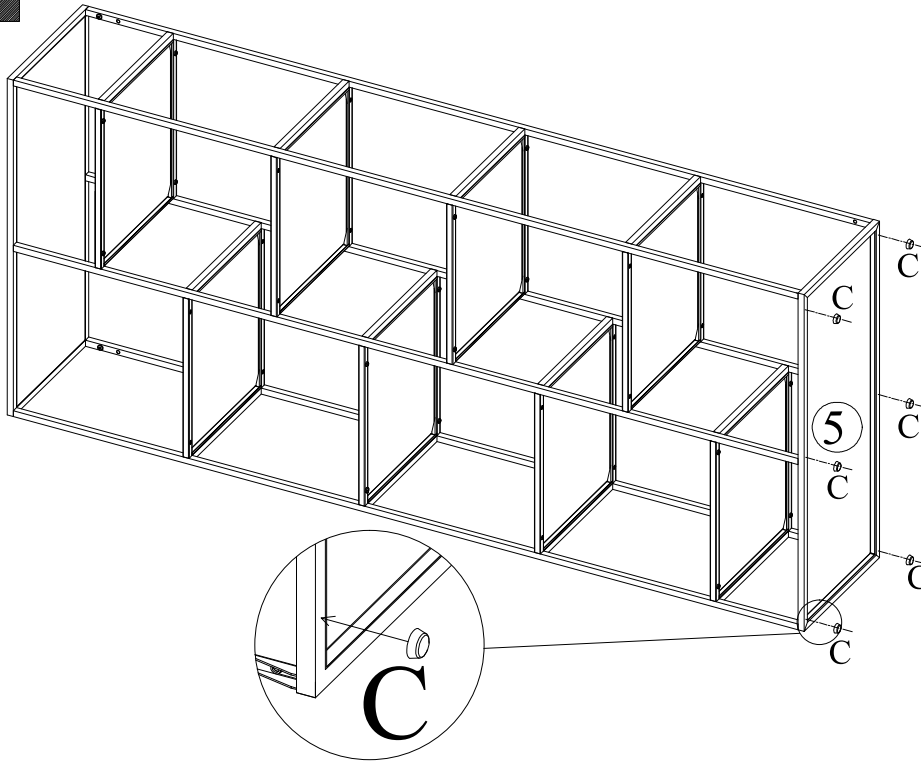

8

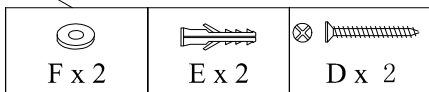
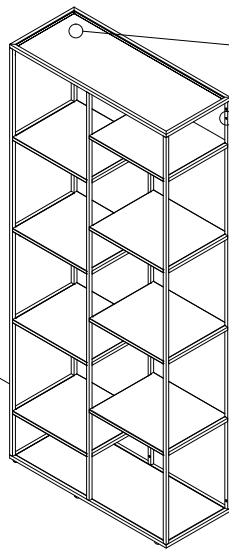

- MOUNTING INSTRUCTIONS -

NL: Deze kast bevat twee gaten aan de achterkant voor montage aan de muur. Wij raden u ten eerste aan de bijgeleverde pluggen en schroeven te monteren om te voorkomen dat de kast per ongeluk valt en letsel of schade veroorzaakt.

1. Plaats de kast eventueel met hulp van een ander persoon, tegen de muur op de gewenste plek.
2. Markeer de muur met een potlood licht door de twee gaatjes aan de achterkant van de kast en verplaats de kast voorzichtig opzij. Boor gaten op de plek van de markeerpunten.
3. Monteer de plug in de muur bij elk markeerpunt totdat het brede uiteinde gelijk komt met het oppervlak van de muur.
4. Plaats de kast tegen de muur op dezelfde plek waar je de twee pluggen door de twee gaten kunt zien. Gebruik een schroevendraaier om de schroef vast te zetten in elke plug en draai elke schroef met de klok mee tot hij vastzit.
5. Klaar!

UK: This cabinet includes two holes on the back for mounting to a wall. We strongly recommend that you install the provided anchors and screws to prevent the cabinet from accidentally falling and causing injury or damage.

1. Perhaps with the help of another person, position the cabinet against a wall at a desired location.
2. Use a pencil to lightly mark the wall through the two holes that on back of the cabinet. Then carefully move the cabinet aside. The mounting hardware will be installed at these two insertion marks.
3. Install the anchor into the wall at each insertion mark until the wide end becomes even with the surface of the wall.
4. Position the cabinet against the wall at same location that we can see the two installed anchors through the two holes. Use the screwdriver to secure a screw into each installed anchor. Rotate each screw clockwise until tight.
5. Done!

