

# THOMAS

## corner sofa

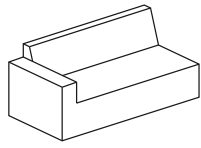

+1x

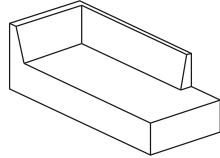

+1x

+3x

+2x

+5x

+6x

+14x

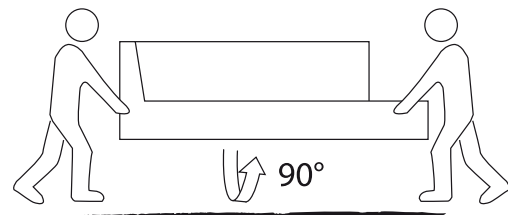
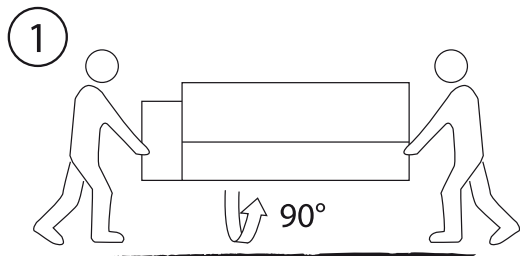

②

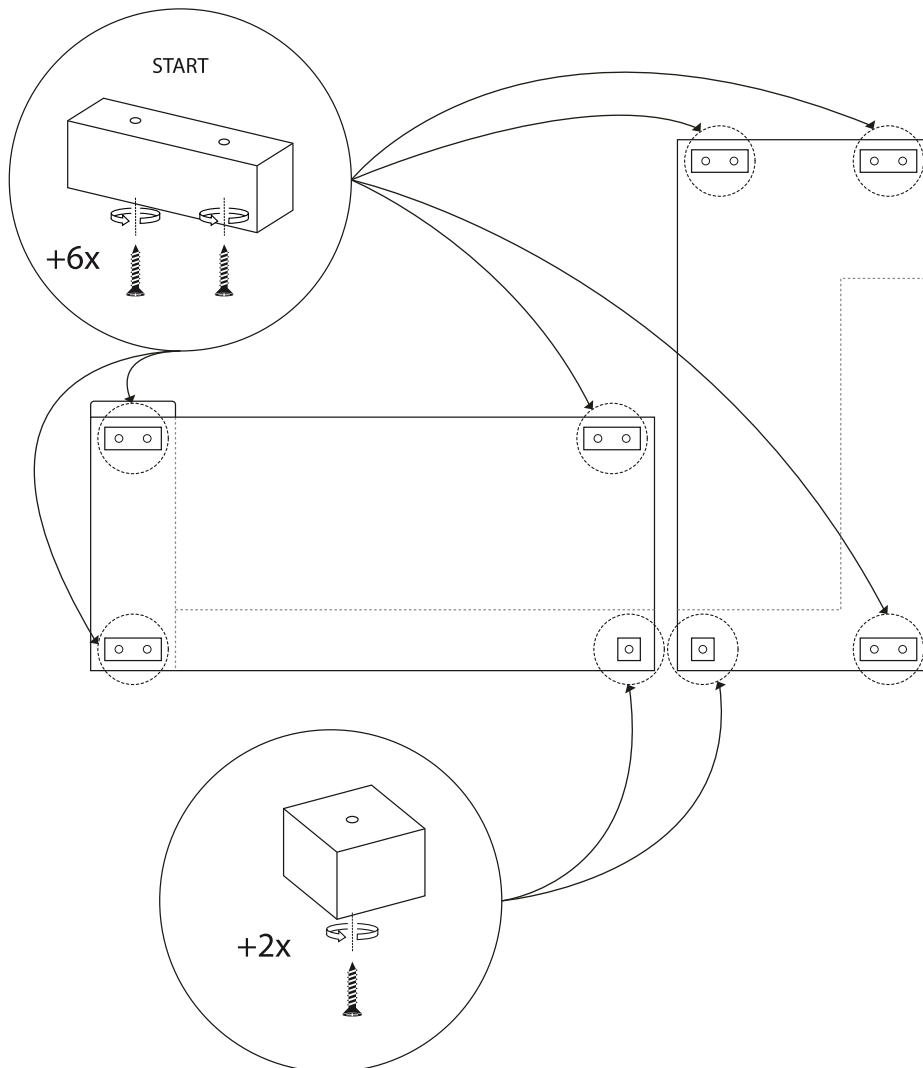

3

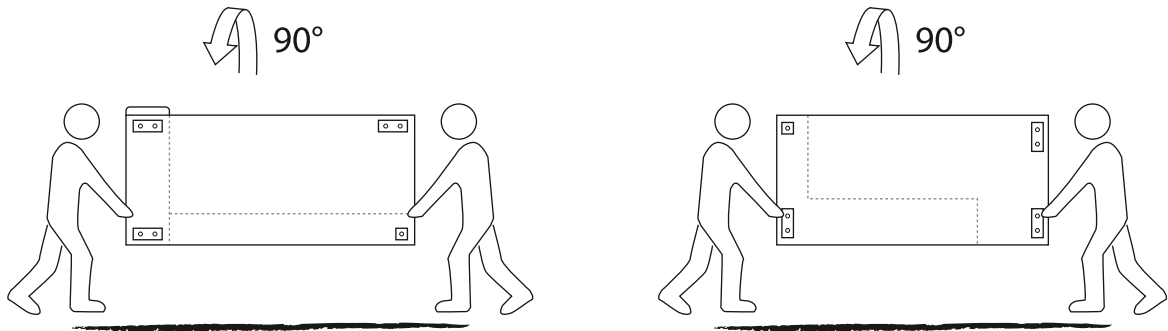

4

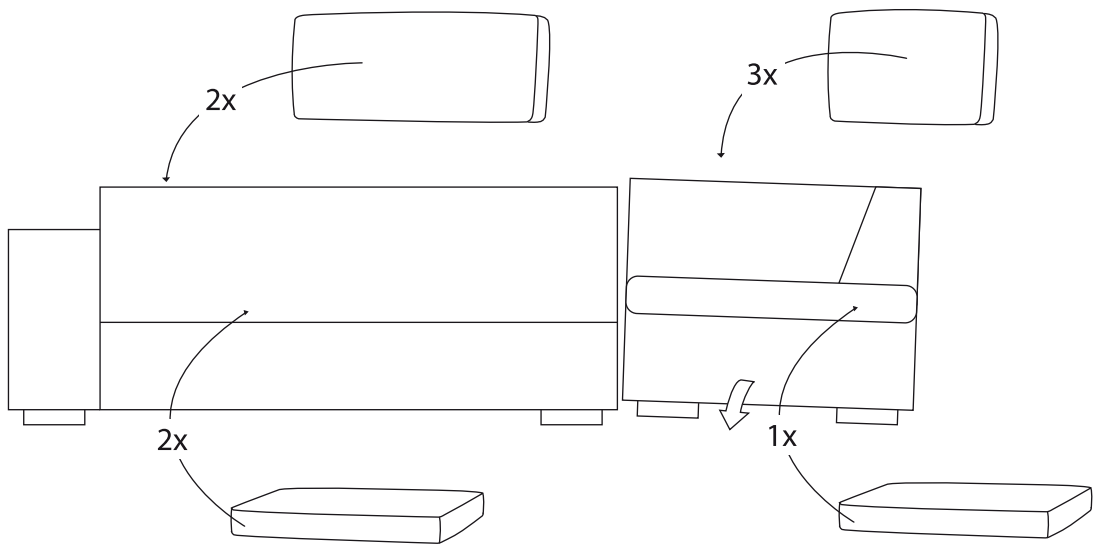

5

